

added jumper wire from base via of Q14 to via between x4 x8, near JP1 location

added jumper wire in place of R54

added jumper wire in place of R60

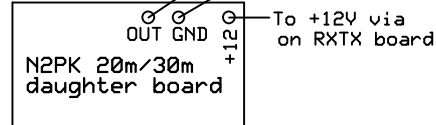

daughter board mounted 1/8 inch above RXTX board with JP100 of daughter board in line up with JP2 of RXTX board

20m/30m kit

L4 1.0 uH, 17T of #30, (10 in.), on T30-6 core (yellow)
 T4 0.42 uH primary, 11T of #30, (9 in.), on T30-6 core (yellow)
 T4 secondaries 5T of #30, (2 x 5 in.), wound bifilar

Notes:

Omit the following components from the RXTXv6.2 board:
 C43, C44, C45
 Q13, Q14
 R54, R55, R56, R57, R60
 X1, X2, JP1, JP2

Add wire jumpers as follows:

- 1) in place of R54, mount flat to board
- 2) in place of R60, mount flat to board
- 3) from +12 via on daughter board to +12V via on RXTXv6.2 board
- 4) from base via of Q14 location to via between x4 and x8, near JP1 location, mount flat to board
- 5) from OUT via of daughter board to via #2 of JP1 location
- 6) from GND via of daughter board to via #4 of JP1 location

R58 and R59 are 1/8 W size 10k resistors from daughter board kit pack and are mounted flat to PCB

Note: Components mounted to the bottom of the board include size 1206 SMT capacitors C50 through C73 and SOICs U1, U2, U3, U5, U6, U7 and U8

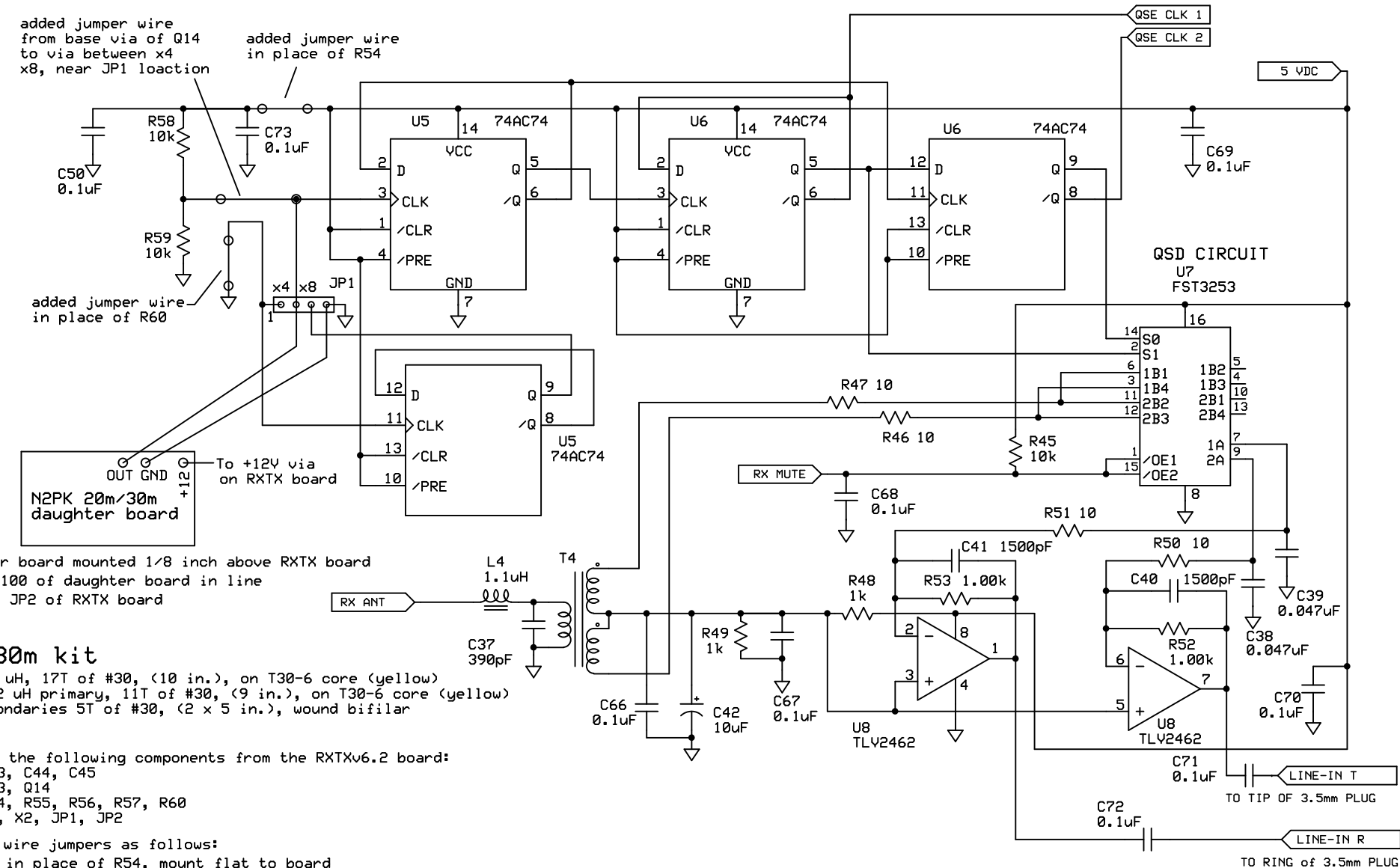

SoftRock Projects

N2PK 20m/30m RXTXv6.2 with daughter board
 (Modification of G0BBL-M0PUB-G8BTR RXTXv6.2)

Tony KB9YIG

8/17/07

Page 2 of 2